

Add:

No.18, Dong' an Road, Chengxiang Industrial zone,
Taicang, Suzhou city, China
地址: 江苏省苏州市太仓城厢工业园东安路18号 邮编: 215400

电话:

0512-53635119 15806226268 15806226098

Tel:

+86 -512- 53635119 15806226268 15806226098

Fax:

+86 512 53635119

E-mail: sales@jwell.cn

COMPLAINT E-mail: info@jwell.cn

<http://www.jwell.cn> www.szjwell.com

苏州杰威尔精密机械有限公司

SUZHOU JWELL PRECISION MACHINERY CO., LTD.



版本号Edition No.: 2021.03



www.jwell.cn www.szjwell.com

EXTRUSION DIES

平模头

Suzhou Jwell Precision
Machinery Co.,Ltd.

苏州杰威尔精密机械有限公司

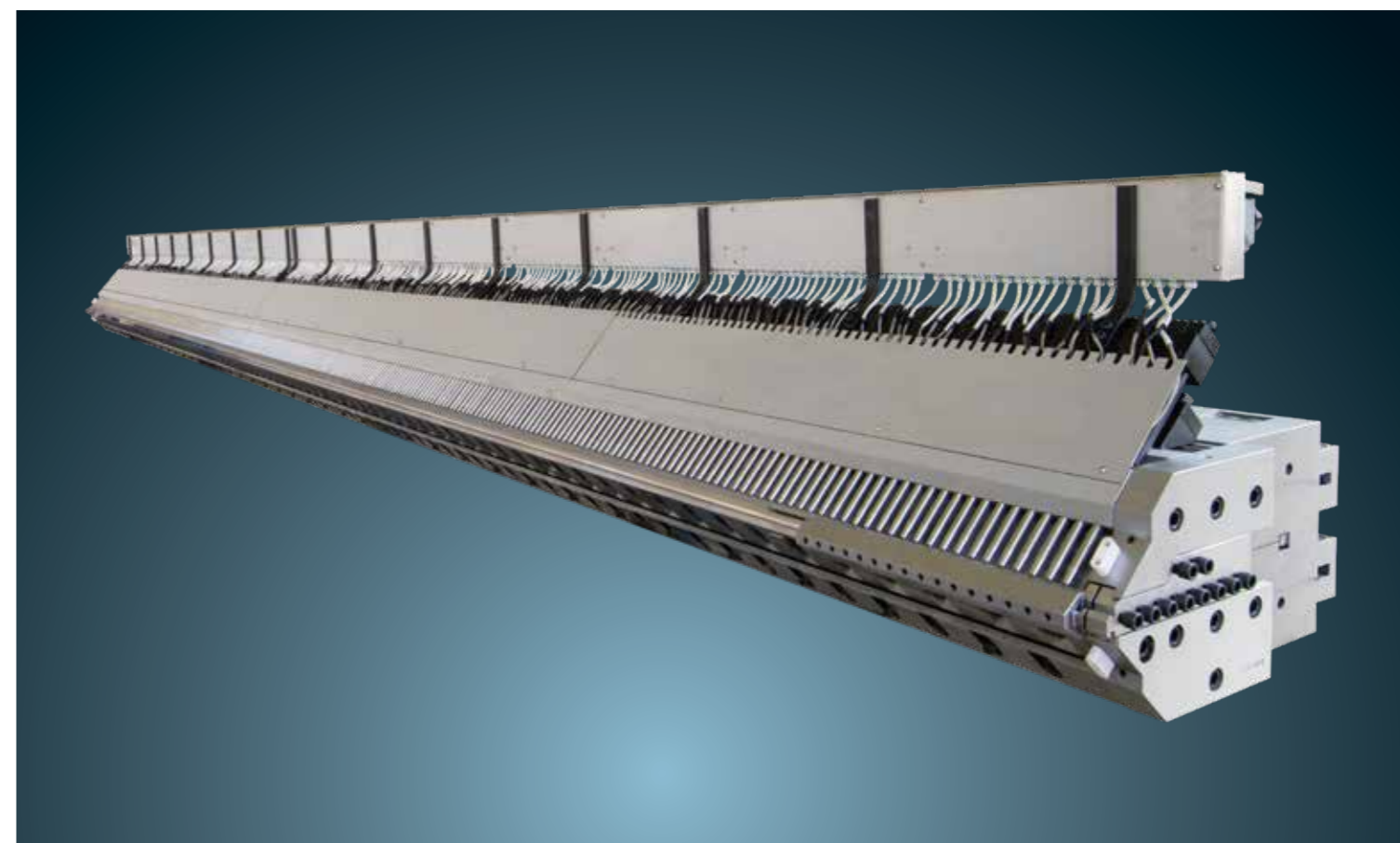

SUZHOU JWELL PRECISION MACHINERY

——专注塑料挤出平模头制造和技术服务

Focus on plastic extrusion die manufacturing and technical services

苏州杰威尔精密机械有限公司是专业的平模头挤出系统制造商。专业生产各种塑料片材、板材、薄膜、涂覆等各种单层或多层共挤模头，以及分配器、熔体计量泵、换网器、镜面辊筒等，我们致力于为塑料产业提供最具价值的挤出成型系统；丰富的生产制造经验和持续的技术创新，配以最现代化的加工设备，使产品日趋完美，广泛适用于PP、PE、PET、GPPS、HIPS、ABS、PC、PMMA、PVC、EVA、PVB等原料的生产。

JWELL所生产的每一副模头都是根据客户的具体要求专门精心设计的，我们的工程技术人员会和每一个客户进行合作协调，以确定模头的设计方案、模身材料、流道表面、温度控制、厚度调节、宽幅调节和其他基本因素。

“品质卓越、完美如一”是杰威尔公司的质量方针；

“诚实待人”是我们的核心理念；

JWELL将努力创造卓越的模具精品，提供周到完善的服务，协助客户和合作伙伴创造更多的价值。

董事长：何海潮

Email: he@jwell.cn

Suzhou Jwell precision machinery co., ltd. is a professional T-die extrusion manufacturer. Specializing in the manufacturing of different kinds for sheet, plate, film, coating single-layer and multi-layer co-extrusion die series, Various kinds of distributors, melt pumps and hydraulic screen changer, mirror roller etc, we devote ourselves work for plastic producer to provide the most value of the extrusion system; With the abundant manufacturing experience and continuously technical innovation, equipped with modern CNC processing machines,our company is making the products more perfect. Our products widely used in PP, PE, PET, GPPS, HIPS, ABS, PC, PMMA, PVC, EVA, PVB etc raw material production.

Each T-die manufactured by our company' s engineer that according to customer requirement. Our engineers coordinate with the customer to confirm the T-die design, material to be used, flow channel, temperature control. Thickness adjustment, withd adjustment and other factors of the T-die.

"Excellent quality, perfect as one" is our company quality policy "Honesty and treat people" is JWELL's core concept. We will try to create more superior die series with high-quality, provide thoughtful services, to help customers and cooperation partners to create more value.

President: He Haichao

Mobile / WhatsApp +86 13601628188



Film Die Series

薄膜模头系列



自动流延膜模头

此模头采用加长V水滴形流道,三角形分流技术以及特殊的稳流结构.有效提高各复合层的复合精度以及减少挤出过程中的‘M’形和‘W’形料流产生。上模唇采用推出式手动微调+自动微调一体式模唇,手动调节范围 $\pm 1\text{mm}$,自动调节范围 $\pm 300\ \mu\text{m}$;自动模唇调节控制部分我们采用的是目前非常先进的全闭环控制系统和自动测厚系统,使得产品的厚薄精度在 $\pm 2\%$ 以内,在线测厚仪在高频率不间断自动横向检测扫描,能够非常实时准确的显示制品的厚度公差。在线测厚仪检测数据经过电脑程序处理后,反馈给特殊的模唇热膨胀调节螺栓,实现对模唇的开口厚薄进行自动微调,快速有效的控制产品精度。并且我们的模头拥有良好的扩展性,可以根据客户的需求选配带除厚边装置的“内堵式宽度调节装置”或“外堵式宽度调节装置”,更好的满足客户生产多种宽幅产品的可能,实现更节约、更高效的生产。

该类模头适合与生产5000mm以下,厚度在0.06-0.18mm的CPP、PE、EVA、PVC、PET、PVB、PA等单层或多层薄膜。



Auto-casting Film Die series

The die head adopts an extension V shape water-drop type flow channel,with the shunt technology and special triangle stabilize structure. To composite layer and improve the precision of the extrusion process to eliminate 'M' shape and 'W' shape flow patterns effectively. The upper die lip using push-off type manual fine-tuning + automatic fine-tuning one-piece die lip, manual adjustment range is $\pm 1\text{mm}$, automatic adjustment range $\pm 300\mu\text{m}$; About the automatic die lip adjustment control parts ,we use currently very advanced fully closed loop control system and the automatic gauging system makes the product thickness in $\pm 2\%$ precisely, on-line thickness gauge is automatic continuous detecting scanning frequently, can shows the very real-time accurate thickness tolerance of the products. Through computer program processing the data, feedback to special die lip adjusting bolt thermal expansion, and to realize the opening of the die lip thickness for automatic fine-tuning, fast and effective control product thickness precisely. And we have good die head scalability, according to customers' needs , matching with different "inside blocking type width adjusting device" or "the outer blocking type width adjusting device", be better satisfied customer's needs to more efficient production.

The die head suits for production under 5000mm,thickness between 0.06-0.18 mm CPP, PE, EVA, PVC, PET, PVB, PA, single-layer or multilayer films.

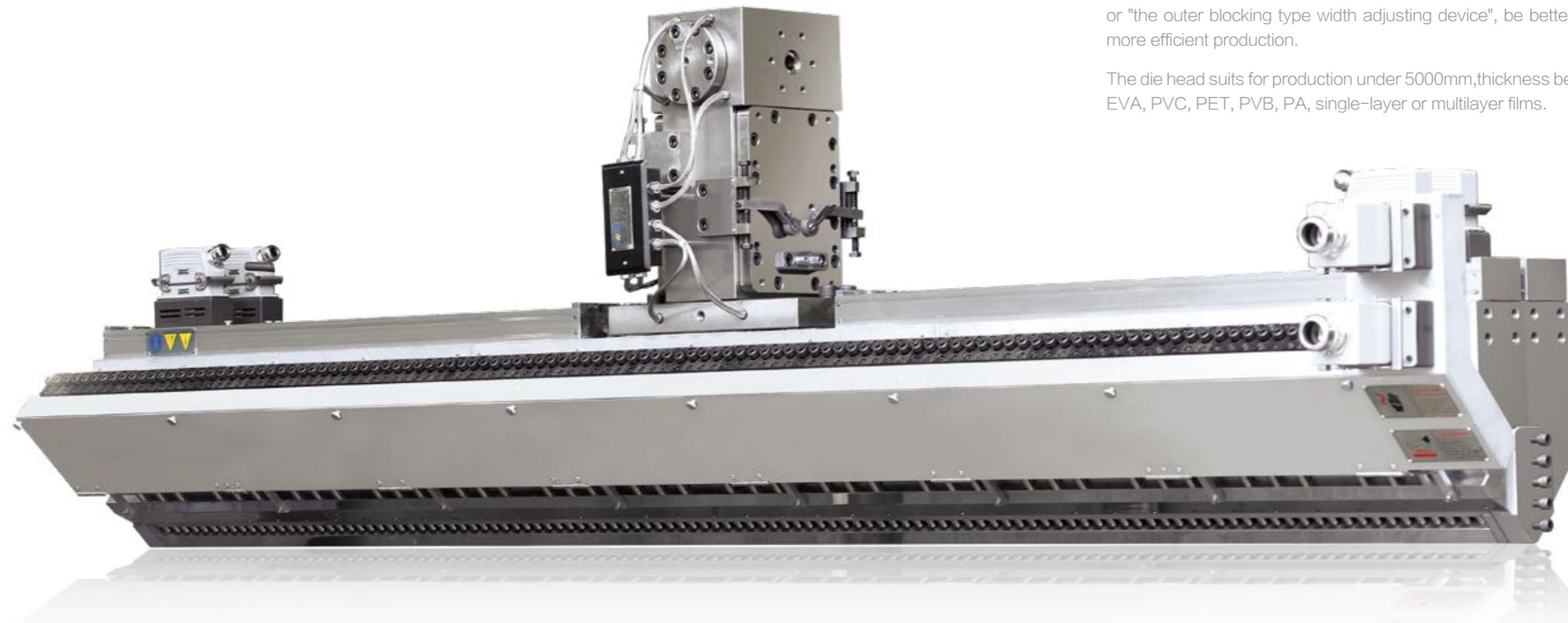

Hollow Cross Section Plate Die Series 中空格子板模具系列



PC中空阳光板广泛适用于建筑装潢、采光隔热、隔音屏障等领域。中空阳光板模具配有均匀涂覆UV层的分配器，可生产宽度为2100mm的中空制品，其耐候性、抗紫外线、耐冲性、透光率等性能极佳。模具带有上、下弹性微调模唇可调节制品壁厚误差 $\leq 3\%$ 。不同的结构设计适应各种产品要求，通用型阳光板厚度从4-25mm，多层结构板包括H型、X型等结构，厚度可达36mm以上，并可以双面涂覆抗紫外线层。

专用模具生产的PP、PE中空格子板因具有材质轻、强度高、防潮等性能适用于周转箱、灯箱广告、布展材料等方面。制品厚度范围2-12mm，宽度1200-2200mm。

PC hollow plate used widely in constructions and decorations. The hollow grid plate die and feedblock can make UV protection on both sides. The final production with a max width of 2100mm and have a high impact strength, good weather resistance and UV protection. With adjustable upper and lower mold lips, production thickness relative errors can be controlled within 3%.

Different design can meet the different requirements of products, general polycarbonate hollow plate whose thickness is between 4-25mm, multi-layers plate such as H-cross section, X-cross section etc, the thickness of some can reach 36mm, and the UV layer can be coated.

The PP, PE hollow grid plate produced by special dies are light weighted, dampproof and have a high impact strength, which is widely used as advertising light panel, exhibition upholster, carry box etc. The thickness-range is 2-12mm and the width is 1200-2200mm.



U type Lock PC hollow cross-section mould series U型锁扣阳光板模具系列

模具芯棒经专用设备工艺切割，采用精度高达 $0.015-0.03 \mu m$ 的精抛光工艺，料流顺畅。模头上，下模唇弹性微调设计使制品壁厚误差 $\leq 3\%$ 。全封闭内置电热管分区控制，安全美观。模具采用隔热板装置实现优化工艺温度，减小热量损失。定型模独立分区控制的均匀抽真空装置及温度控制系统，配有真空密封边装置。模具适合于生产PC厚度范围4-40mm，宽度600-1050mm规格的U型锁扣阳光板制品。

模头所生产的制品重量轻，强度高，安装简便，可弯曲性强，被广泛用于大型市政工程、建筑采光屋面、游泳池顶棚、工业屋顶及采光天棚、农业温室、厂房屋顶等公共设施。

Mould core rod adopt the special equipment cut, and the high precision polishing process. To make sure to the smoothly flowing of the materials.

In the die head, the elastic fine-turning design make the tolerance of the product wall thickness $\leq 3\%$. Fully built-in zone control electric heating tube, safe and beautiful. The mould adopt the Heat shield device to Realize optimization of process temperature In order to reduce the loss of heat. The even vacuum system and the temperature control system which are separately zone controlled by the calibrator mould equip the vacuum sealing strip equipment. The mould can be used to produce U type Lock PC hollow cross-section products, thickness range from 4-40mm and width range 600-1050mm.

The PC hollow products produced by special dies are light weighted, high impact strength, easy installation, good flex characteristic, is widely used as Large municipal engineering, the roof of the building, The roof of the swimming pool, Industrial roof, the Lighting ceiling, Agricultural Greenhouses and so on communal facilities.

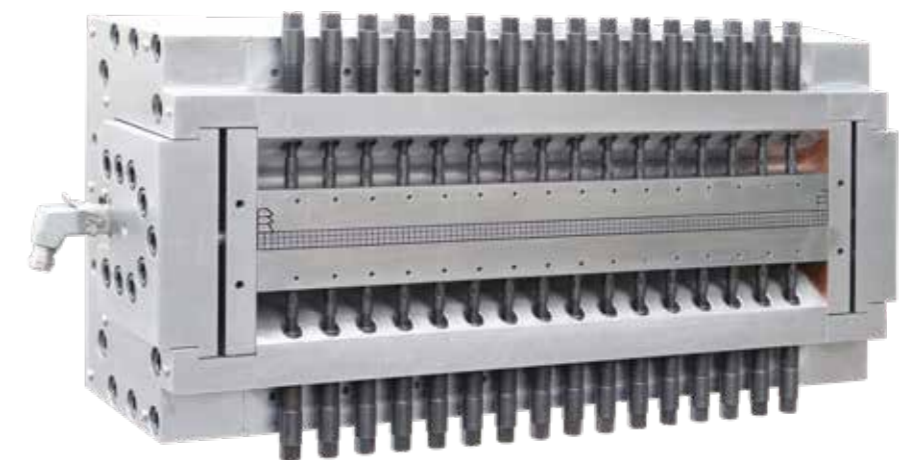

High-speed Film Coating Die Series

高速淋膜模头系列



杰威尔公司生产的高速淋膜模头采用特殊T型歧管流道设计，配合手动内堵式宽度调节装置可在线不停机改变宽度，各级独立可调的封边系统可最大限度地减少厚边的形成，有效减少聚合物和基材的浪费。该类适用于生产宽度在5000mm以下，厚度0.012-0.12mm的PP、PE、PET、EVA等淋膜。

特点:

快速准确地调整宽度: 封堵组件整体动作一次，完成封堵系统调整，待制品达到理想的边厚要求，封堵系统调整设置即被固定下来，再次改变宽度时均无须再对封堵系统进行重新调整。

快速清理与维护: 可快速打开除厚边宽度调节系统，方便清除导致模头拉线的碳化聚合物。

高效密封结构: 采用先进的冷却密封结构，可确保长期生产不漏胶。

安全: 采用全封闭内置不锈钢加热棒加热，高效节能。

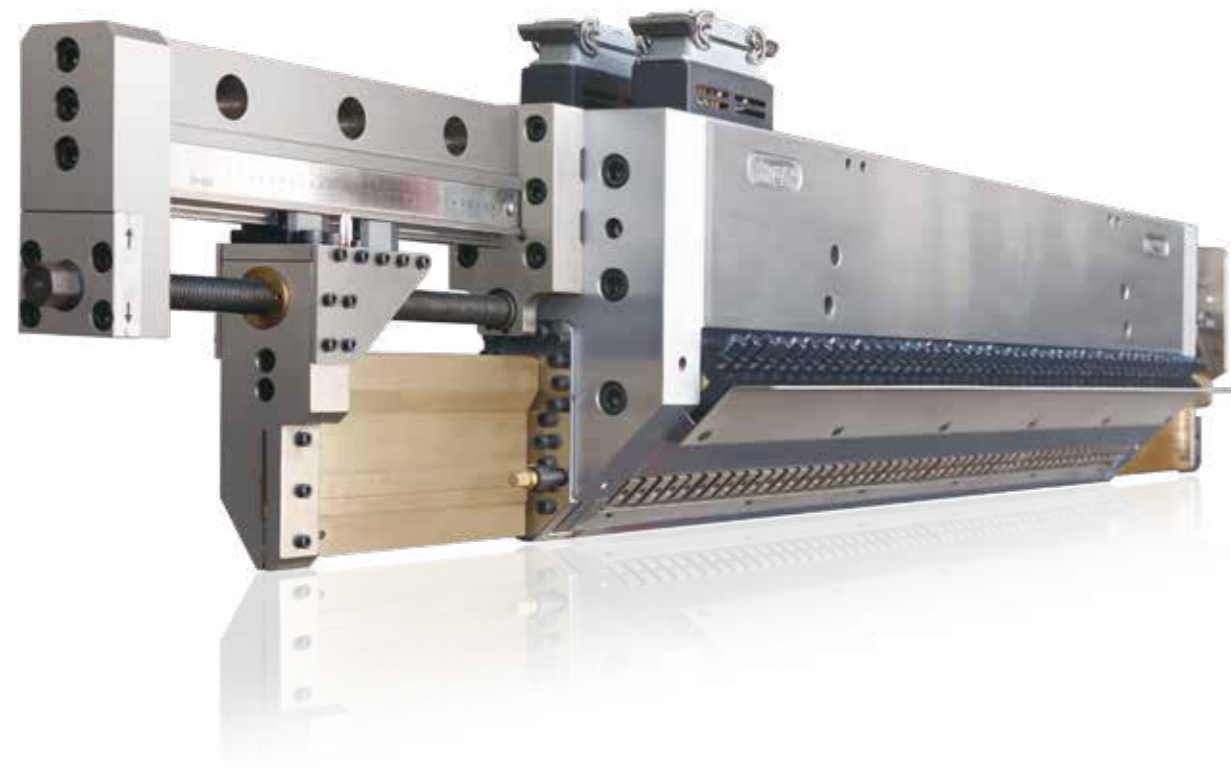

Jwell Company's high-speed film coating die adopt T-type thick edge with manual adjustment system to simplify the product width switching operation and online adjusting. Each independent edge adjusting system can minimize the thick edge issues. Thus effectively reducing the waste of the polymer and the substrate. This dies suitable for the produce the width below 5000mm, thickness of 0.012-0.12mm of PP, PE, PET, EVA coating products.

● **Quickly and accurately adjust the width:** the overall action of the closure assembly to complete width adjustment. Once the products to achieve the desired edge thickness requirements, adjust the settings of the closure system is fixed down after repeated adjust the width are no longer re-adjust closure system.

● **Quick clean-up and maintenance:** The operator can quickly open the thick edge width adjustment system, insert the brass scraper to remove carbonized polymer.

● **Highly efficient sealing Structure:** Uses a unique cooling sealing structure, to ensure the long-term production of plastic does not leak.

● **Safety:** Adopts incomplete closure of the built-in stainless steel heating, efficiency and energy saving.



Sheet Die Series

片材模头系列



JW-P-K1

快速开口系列模头，上模唇推拉式微调，柔性下模唇可实现不停机在线快速调整制品厚度规格，调节范围最大达5mm，带45度节流棒调节装置，适用生产PC、PS、PP、PE、PLA等单层或多层片板。

Fast opening die series, the upper die lip with fine-tuning push-pull type, the flexible lower die lip can adjusting product thickness on-line without stop, the Max adjusting range up to 5 mm, Equip with 45° blocking bar, it is suitable for produce PC, PS, PP, PE, PLA, single-layer or multi-layer plate .



JW-P-A1

标准衣架式流道设计，上模唇可微调，适用生产PET(APET、PETG) PC、PS、PP、PLA等，单层或多层片板，宽度≤2100mm，厚度0.14-2mm。

With coat-hanger channel, micro-adjustable upper die lip, the die is perfect for single-layer or multi-layer PET(APET, PET)PC, PS, PP, PLA plate with the width ≤2100mm, and the thickness between 0.14-2mm.



JW-P-AT1

自动调节模头，上模唇含自动控制单元，分为手动调节和自动调节两部分，手动调节范围在1mm。自动调节范围在300um。适用PC、PS、PP、PE、PLA等不同宽度的单层、多层片材或薄膜。

Auto-adjusting die, the upper die lip is adjusted by the auto-control system which divided into manual-control unit and auto control unit; the first can control the accuracy in 1mm and the latter 300um. Fits for PC, PS, PP, PE, PLA single-layer or multi-layer sheet or film with different width.

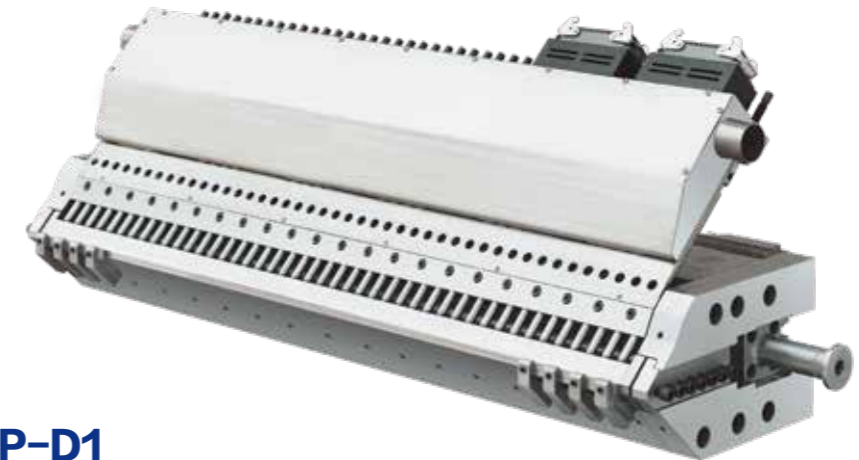

JW-P-D1

模内复合模头，通过多流道模内复合，可有效提高各层面的薄厚精度。上模唇可微调、下模唇固定及芯层45度节流棒调节装置，适用生产PC、PS、PP、PE、PLA等多层共挤片材。

With multi-manifold design, the die can combine the materials inside to ensure the accuracy of the film. The die adopts micro-adjustable upper die lip, fixed lower lip and 45° blocking bar, which is fit for PC, PS, PP, PE, PLA multi-layer co-extrusion sheet.

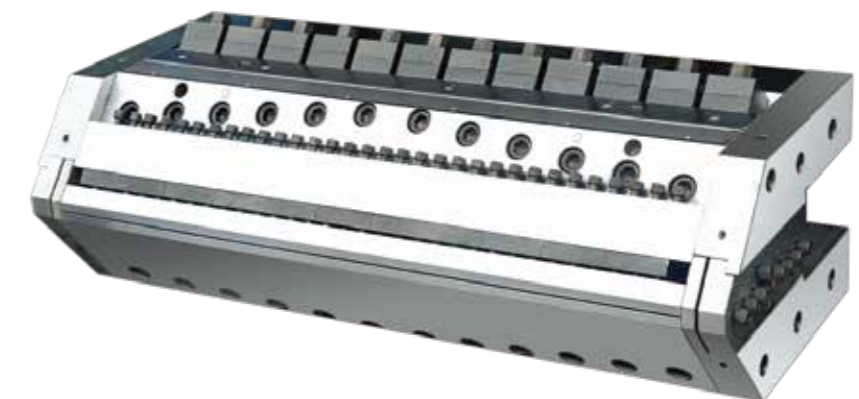
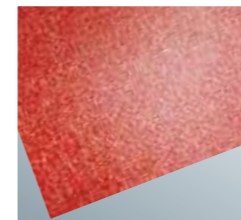

Sheet Die Series 片材模头系列



JW-P-C1

标准衣架式流道设计，上模唇可调、下模唇可换及45度节流棒装置。适用生产PVC、PS、PP、PE、PC等单层或多层片材，制品厚度0.8-12mm。

With coat-hanger channel design, adjustable upper die lip, changeable lower die lip and 45° blocking bar, the die is fit for PVC, PS, PP, PE, PC single or multi layer sheet with the thickness of 0.8-12mm.



JW-P-C2

模头采用渐变水滴形平肩式流道，配合三角形分流技术，阶梯式稳流，有效消除了挤出过程中因高压导致模口变形。上模唇为手动推出式微调弹性模唇，调整精确，平面式节流棒，能够消除物料滞留，解决因停留过长导致分解。下模唇可换，可根据不同厚度配备不同开口的模唇。适用生产PC、PS、PP、PE、PLA、PVC等单层或多层片板。

Adopting gradually water drop shape and flat shoulder type flow channel ,with triangle diversion technology, ladder style flow, effectively eliminate the extrusion process for high pressure lead to mould mouth deformation.The upper die lip is a manual push-off type fine-tuning elastic modulus lip.precisely adjustment,with a flat blocking bar can eliminate the material stranded, solve the materials decompose problem because of stay too long.The die lip can exchange, according to different thickness equipped with different open die lip. Applicable for PC, PS, PP, PE, PLA, PVC single-layer or multi-layer plate.



Plate Die Series 板材模头系列



JW-B-C1

标准衣架式流道设计，上模唇采用推拉式或推出式微调，下模唇可换，调节范围最大达5mm，适用生产PC、PMMA、GPPS、PET、等单层或多层高透明片材或板材。

Standard coat-hanger design, the upper die lip adjusting adopts the push-pull type or push-out fine-tuning type;the lower die lip can exchange, the maximum adjusting range up to 5 mm, it is suitable for the production of PC, PMMA, GPPS, PET, single-layer or multi-layer high transparent sheet or plate



JW-B-A2

重型模头采用标准衣架式流道设计，上模唇可调、下模唇可换及45度调节阻流棒调节装置，能够满足不同厚度制品的需求。适用生产宽度在2000mm以下，厚度3-30mm的ABS、PE、PP厚板。

With special coat-hanger channel design, adjustable upper die lip, changeable lower die lip and 45° blocking bar, the die adapt to ABS, PE, PP thick plate with the width below 2000mm and thickness between 3-30mm.



Plate Die Series 板材模头系列



JW-B-A1

特殊衣架式流道设计，能最大限度上减少热敏性材料在挤出过程中的烧蚀。上唇可调、模唇可换及垂直节流棒调节装置，能满足不同厚度制品的需求。适用生产PVC自由发泡板材，制品厚度2-20mm。

With special coat-hanger channel design, the die minimizes ablation of heatsensitive material. With the adjustable upper die lip, changeable lower die lip and perpendicular blocking bar, the die meets the thickness requirements of various products. The die is fit for PVC foaming board with the thickness between 2-20mm.



JW-B-B1

标准衣架式流道设计，上模唇可调、下模唇可换及垂直节流棒调节装置。配ST型模唇挡块，能够在线快速调节制品宽幅。适用生产ABS、PS、PP单层或多层板材，制品厚度0.8-8mm。

The die adopts a typical coat-hanger channel, and adjustable upper die lip, changeable lower lip and perpendicular blocking bar. With ST-model width-control system, the width of products can be changed without interrupting. The die is designed for ABS, PS, PP single-layer or multi-layer plate with the thickness between 0.8-8mm.

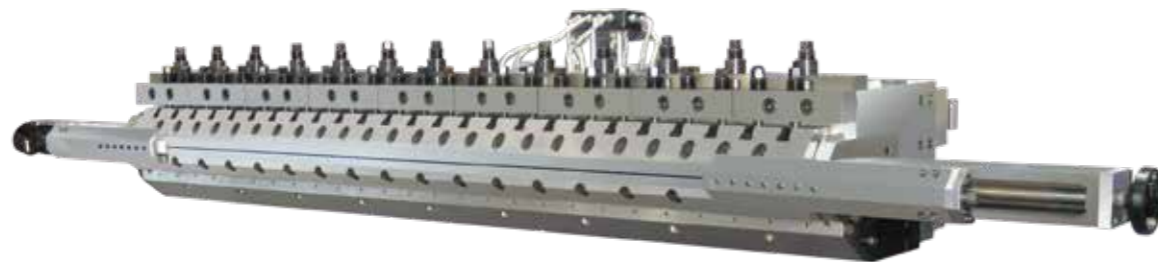

PVC Coating Die Series PVC涂覆模头系列



JW-F-A1

PVC涂覆模采用特殊衣架式流道设计及独特的模唇结构，上模唇可调及垂直节流棒调节装置及涂层厚度可调，通过成对使用，可生产不同厚度、不同规格的专用运输带。该产品被广泛用与矿山，仓储，运输等场合；标准规格(mm)：650、800、1000、1200、1400、1600、1800、2000。

PVC coating die adopts special channel of coat-hanger structure, adjustable upper die lip, perpendicular blocking bar, the thickness of production can be adjusted. In pairs, special-purpose conveyer belt with different thickness and size can be produced. This kind of products are widely used in mining, storage, transportation and so on; Specification(mm): 650, 800, 1000, 1200, 1400, 1600, 1800, 2000.

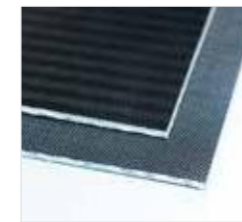

Waterproof Sheet Coil Die Series

防水卷材模头系列



8米防水卷材模头

8 meters waterproof sheet coil die

PVC、EVA、PE新型防水材料具有较强的抗渗透性，有良好的防水性能，较高的耐高温、低温性能，有较好的强度及延伸率，并有优异的耐老化性特点。广泛应用于工业与民用建筑的屋面防水、建筑物地下防水、隧道防水、人工湖防水等。

特点:

- 计算机辅助歧管设计使物料分布均匀，使宽幅制品得以实现。
- 加长的模唇提高了成品取向的一致性，降低了模头膨胀，对调节的反应灵敏度大大提高。
- 在模腔中心处歧管与口模结合处所形成的曲线相贯线能够改善物料的侧向流动和分配。
- 上模唇可微调，下模唇可更换可生产不同厚度制品(1-4mm最大可做到10mm)。
- 带有节流棒调节功能，能适用不同原料、不同厚度制品的挤出。

PVC, EVA, PE new type of waterproof material have high performance of anti-permeability, water-proofness, thermo-stability and cryogenic property, high strength and elongation and have the characteristic of aging resistance, are widely used for waterproof in building roof of industry and civil construction, underground, tunnel, artificial lake, etc.

Characteristics:

- CAD of manifold making the material distributing uniformly and realize the wide products.
- The lengthening die lip improved the uniform orientation, reduced the expansion of die, highly improved the reaction of regulating.
- Line of intersection for curve formed on the joint between the center manifold of die chamber and die lip can improve the flow of side directions and distributing.
- Micro-adjustable upper die lip and changeable lower die lip for producing different thickness (1-4mm, the maximum is 10mm).
- With the function of restrictor bar adjusting and be suitable for the extrusion of different materials and thickness.



Biaxially Oriented Die

双向拉伸模头



挤出模头是双向拉伸设备中的关键部件，直接决定铸片的外形和厚度均匀性。该类双向拉伸铸片模头采用衣架型流道设计，并借助专业的计算机流体分析软件进行流道模拟分析和优化，以此获取最佳的流道参数。模唇采用推拉式自动调节模唇，可通过在线测厚仪的检测到的厚度数据经过电脑程序处理后反馈给特殊的模唇热膨胀调节螺栓，实现对模唇的开口厚薄进行自动微调，快速有效的控制产品精度；此类模头可适用于：BOPP、BOPS、BOPA、BOPET、BOPI等。

铸片模头唇口的直线度，粗糙度和唇口尖角大小直接影响产品质量，经过我们的实验与论证，模唇经过局部硬化处理后可有效改善模头质量。如表面硬度高，金相组织细化，耐磨性优于传统淬火工艺等优点，且经过硬化后的模唇能够得到更好的直线度和耐磨性。

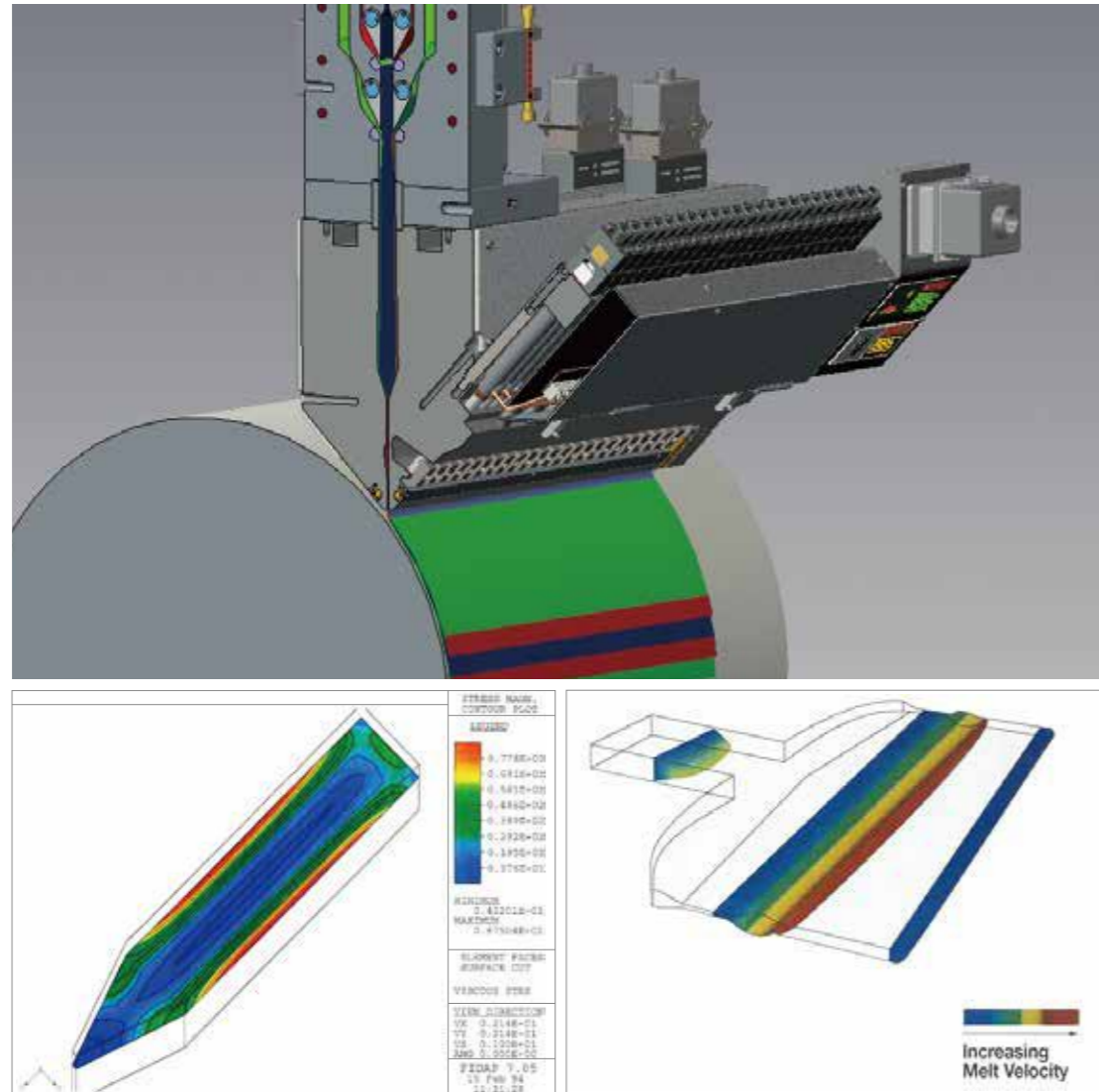

The die is crucial part of the biaxially oriented cast sheet, directly decided to cast sheet shape and thickness uniformity. This biaxially oriented casting sheet die adopt coat hanger flow channel design, and equip with professional computer fluid analysis software, Flow channel CFD analysis and optimization, to obtain the best fluid parameters. Die openings adjustment adopts the push-pull type automatic die lip adjustment, through online thickness gauge of the thickness of the detected data through computer program processing after feedback to the special die lip thermal expansion regulating bolts, for the opening of the die lip thickness automatic fine-tuning, effective control of product precision. This die applicable for: BOPP, BOPS, BOPA, BOPET, BOPI products etc.

The die lip straightness, roughness and the size of the lip sharp angle is direct impact on the quality of products. After experiments and repeated demonstration, using short-wave pulse local hardening treatment can be effective in improving the quality of the die. so that hardened surface hardness, microstructure refinement, wear resistance superior to conventional quenching process. The die lip straightness and abrasion resistance is better.



Narrow Gap Coating Die Series

窄缝涂覆模头系列



窄缝涂布模头可以生产出非常薄的涂层以及透明的光学涂层，同时可使涂层量保持在非常精确公差范围内，与将涂布液擦拭到基材上的涂布系统不同，我们的窄缝涂布模头属于模唇缝隙相对较大（可达到0.0762mm）的涂布模头，由此模唇缝隙抽吸出的液体可形成最薄至1 μ m的涂层。窄缝涂布模头可在涂层厚度只有0.002mm或者是2 μ m的情况下，将整个宽度上的涂层量控制在5%左右的公差变化范围内。我们生产的窄缝涂布模头模唇是固定的，因此可以利用可换的控隙片来改变涂层的厚度和宽度。涂布量从不足1 μ m到254 μ m的涂层厚度。该类模头可加工各种类型的胶粘剂（包括特殊的透明胶粘剂）、电池、陶瓷电容器、装饰表面、电子显示介质、过滤膜、地板、燃料电池、磁性泥浆、医疗产品、光阻材料、压敏胶带、太阳能电池、超导体、撕带和窗用薄膜等。

Narrow gap coating die head can produce a very thin coating and transparent optical coatings, also can make the coating is kept in very exact tolerances range, Unlike the wipe liquid coating on the based material, our narrow gap coating die head system belongs to die lip gap is opposite bigger (0.0762 mm) coating die head, so that the thinnest coating will reach to 1 μ m through out the die lip. On the case of the condition thickness only in 0.002mm or 2 μ m, the Narrow gap coating die head system can control the entire width coating capacity tolerance range around 5%. We design the die lip is fixed, so we can use the control feeler blade to control the coating thickness and width. Coating thickness from less than 1 μ m to 254 μ m. The die head can processing all kinds of adhesive (including special transparent adhesives), battery, ceramic capacitor, decorative surface, electronic display medium, the filtration membrane, floor, fuel cells, magnetic mud, medical products, light resistance materials, pressure sensitive adhesive tape, solar battery, superconductor, tore belt and the window with film, etc.



平模头修复升级改造 — 金纬,你的最佳合作伙伴

Extrusion Die Repair Upgraded — JWELL, Your Best Partner

作为挤出平模头专业制造商，我们将为您提供一整套模头清洗、检测、修复、升级、改造等标准服务。

经过JWELL翻新过的模头各项技术指标可以达到或非常接近初始标准。对于非JWELL原产的模头我们同样可以达到该要求。

针对每一套翻新模头我们都将严格按照以下步骤进行:

- | | |
|-----------------------|------------|
| 1、模头拆卸、清理 | 6、修复模体接合面 |
| 2、检查、评估，针对技术翻新要求与客户沟通 | 7、流道进行重新抛光 |
| 3、退除原始镀层 | 8、重新组装模头 |
| 4、修复受损表面或更改缺陷设计 | 9、校对各项技术指标 |
| 5、更换损坏部件 | |

我们为您提供的将是一整套专业流程式作业，服务范围涵盖一般维护到完全翻新。

As China's biggest extrusion equipment manufacturers, we will provide you a whole set standard services with die clean, examination, repair, upgrade, renovate and so on.

Renovates the die each technical specification after JWELL can achieve or very close to the initial standard, we may meet this requirements similarly regarding the non-JWELL production's die.

Every need to repair the die we will strictly according to the following steps:

- 1、The die remove, cleaning
- 2、Inspection, evaluation, and communicate with customer requirements for renovation
- 3、Faded except the original chromium plating
- 4、Repair damaged surface defects or change the defects in design
- 5、Replace damaged parts
- 6、Repairing mold body joints
- 7、The mold flow channel to polish
- 8、Reassemble the die
- 9、Proofreading technical specification

We provide for you will be a whole set specialized flow type work, the range of service covering general maintenance and completely renovated.



Multi-layer Co-extrusion Distributor

多层共挤分配器



复合共挤分配器 适合各种聚合物料，配合挤出平模使用，可按照客户的分层要求，均匀地复合挤出成为薄膜、片材、板材制品。根据适用的塑胶原料和使用情况，有芯棒式、堵块式、摆叶式等形式可供选择，通过更换进料处的分层排序轴改变复合层的排列次序。可以处理的复合层数从2层到60层甚至更多。

Multi-layer co-extrusion feedblocks are suitable for various polymer plastic materials. Bases on the customs' different requirements, a combination of T-die and co-extrusion feedblock provides the most competitive edge for film and sheet production. There are different modes of configuration for different features of plastic materials, layers which the feedblock can manage can reach 2 to 60 or even more.

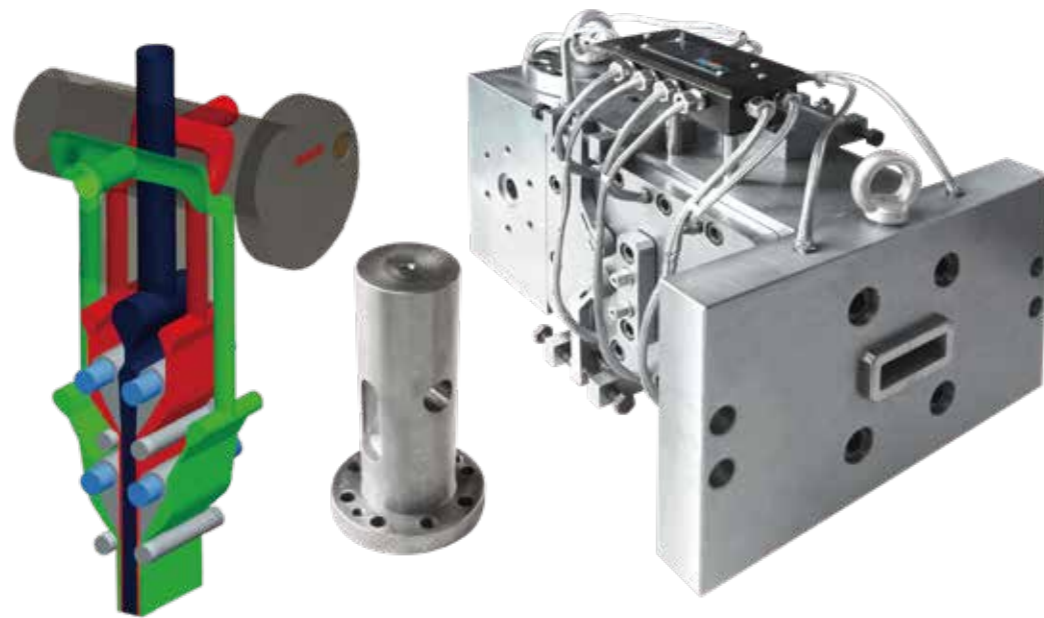

分配器结构图 Illustration of structure of distributor

原料排列方式 Materials feeding form					
流道模式 Running model					
应用实例 Materials feeding form	PS+HIPS EVA+PE PMMA+ABS ABS+HIPS APET+PETG	PS+HIPS+PS ABS+HIPS+ABS HIPS+回料PS+HIPS HIPS+PVC+HIPS PETG+APET+PETG	PMMA+HIPS+ABS PC+ABS+UPVC HIPS+回料PS+PS	PEPS+HIPS+PEPS+PS HIPS+回料PS+HIPS+PS	ABS+HIPS+回料PS +HIPS+ABS PMMA+ABS.PMMA +ABS+ABS.PMMA+PMMA

Screen Changer System

换网系统



JWELL生产的过滤换网系统广泛应用与各类塑料制品挤出、塑胶制粒等领域，完美的设计和精心的制作让产品的性能值得信赖；多种可供选择的结构形式和规格型号，总有一款适合您的过滤要求。

JWELL's hydraulic screen changer system widespread use in all kinds of plastic products, plastic granulation etc, the perfect design and careful production let the product's performance is worth trust; A wide selection of structural form and specifications, always have a suitable for your requirements

手动换网器系列

- 挤出机螺杆可穿过换网器直接拔出，方便拆卸清理。
- 采用先进的压力密封技术，通过聚合物在网前的压力驱动密封元件，达到最佳密封效果，且换网更迅速。
- 模块化组合，适合不同标准挤出机，且清理方便。
- 低成本投资，适合小型挤出系统使用
- 最低的停留时间。
- 最小的安装空间，
- 适合不同的挤出产业。

Manual screen changer series:

- Extruder screw can draw from the screen changer directly, it is convenient to remove and clean
- Adopts advanced pressure seal technology, through the pressure of polymers to drive seal components, to achieve the best sealing effect and change screen more quickly
- modular combinations, suitable for different standard extrusion machine, and convenient to clean
- Low cost investment, suitable for small extrusion system.
- The minimum stay time.
- The smallest installation space,
- Suitable for different extrusion industry.



技术参数 Technical parameter

型号 Model	产量(Kg/h) Output	滤网规格 (mm) Filter size	过滤面积(mm²) Filtration area	最高承压(Mpa) Withstanding pressure	温控分区 Heating zone	加热功率 (KW) Heating power
JW-MT-50	50~100	φ55	1960	20	2	3.3
JW-MT-70	80~150	φ75	3850	20	2	3.3
JW-MT-100	150~350	φ105	7850	15	2	6
JW-MT-120	250~400	φ125	11300	15	2	8

Hydraulic Screen Changer System

液压换网系统



单柱液压换网器系列:

- 无机械密封结构, 保证在高压、高温状态下不渗料。有效降低换网阻力, 减小液压系统的工作压力。
- 一体式结构, 无承载缝隙, 强化承载压力, 使系统承载压力更高。
- 优质合金钢经氮化处理, 大幅延长产品使用周期。
- 整体式工程油缸, 使用寿命更长久。
- 经过流变优化后的蜂窝板, 有效降低了挤出过程中流体剪切。
- 采用内加热装置, 安全节能; 全封闭走线, 美观大方。

Single column hydraulic screen changer series:

- No mechanical seal structure, which can guarantee the high pressure and high temperature condition not seep materials. Effectively reduce the change screen resistance, reduce hydraulic system pressure of work.
- One-piece structure, without carrying aperture, strengthen bearing pressure, make the system load pressure is higher.
- Using High quality alloy steel, after nitriding process to extended product life span greatly.
- Integral engineering oil cylinder, a long use life.
- After optimization of rheological through cellular plate, to reduce the extrusion process fluid shear.
- Using inner heating device, for safe and energy-saving. Fully enclosed wires, for the elegant appearance.



双柱双工位液压换网器系列:

- 无机械密封结构, 保证在高压、高温状态下不渗料; 有效降低换网阻力, 减小液压系统的工作压力。
- 优质合金钢经氮化处理, 大幅延长产品使用周期。
- 整体式工程油缸, 使用寿命更长久。
- 交替式工作模式, 能保证在换网过程中的料流连续、稳定以及工艺参数的可重复性。
- 经过流变优化后的蜂窝板, 有效降低了挤出过程中流体剪切。
- 配合行程位置传感器, 换网更精确, 更可控。

Double column with double working position hydraulic screen changer series:

- No mechanical seal structure, which can guarantee the high pressure and high temperature condition not seep material. Effectively reduce the change screen resistance, reduce hydraulic system work pressure .
- Using High quality alloy steel, after nitriding process to extended product life span greatly.
- Integral engineering oil cylinder, a long use life.
- Alternating work mode, can guarantee the material flow continuous, stability and the process parameters of repeatability, when change the screen
- After optimization of rheological through cellular plate, to reduce the extrusion process fluid shear.
- Cooperate with stroke position sensor, change the screen more accurate, more controllable.



技术参数 Technical parameter

型号 Model	产量(Kg/h) Output	滤网规格 (mm) Filter size	过滤面积(mm²) Filtration area	最高承压(Mpa) Withstanding pressure	温控分区 Heating zone	加热功率 (KW) Heating power
JW-DZ-50	50~100	φ55	1960	40	2	2.4
JW-DZ-70	80~150	φ75	3850	30	2	2.4
JW-DZ-100	150~350	φ105	7850	30	2	3.4
JW-DZ-120	250~400	φ125	11300	25	2	6.4
JW-DZ-150	350~600	φ155	17670	25	2	8
JW-DZ-180	450~1000	φ185	25440	25	2	10

技术参数 Technical parameter

型号 Model	产量(Kg/h) Output	滤网规格 (mm) Filter size	过滤面积(mm²) Filtration area	最高承压(Mpa) Withstanding pressure	温控分区 Heating zone	加热功率 (KW) Heating power
JW-SZ-50	50~150	φ55	1960X2	40	2	7.5
JW-SZ-70	80~150	φ75	3850X2	40	2	7.5
JW-SZ-100	150~380	φ105	7850X2	35	2	9
JW-SZ-120	350~700	φ125	11300X2	30	2	13.5
JW-SZ-150	400~1000	φ155	17670X2	28	2	15
JW-SZ-180	700~1500	φ185	25440X2	25	2	18

Hydraulic Screen Changer System

液压换网系统



单板双工位液压换网器:

- 挤出机螺杆可穿过换网器直接拔出，方便拆卸清理，
- 采用先进的压力密封技术，通过聚合物在网前的压力驱动密封元件，达到最佳密封效果，且换网更迅速。
- 穿透式螺栓与挤出机连接。
- 模块化组合，适合不同标准挤出机，且清理方便。
- 采用内加热装置，安全节能；全封闭走线，美观大方。

Single-panel with double working position screen changer:

- Extruder screw can draw from the screen changer directly, it is convenient to remove and clean.
- Adopts advanced pressure adaptive sealing technology, through the pressure of polymers to drive seal components, to achieve the best sealing effect and change screen more quickly.
- Penetrating type bolts connect the extruder.
- Modular combinations, suitable for different standard extrusion machine, and convenient to clean.
- Adopts the inner heating device, for safe and energy-saving. Fully enclosed wires, for elegant appearance.

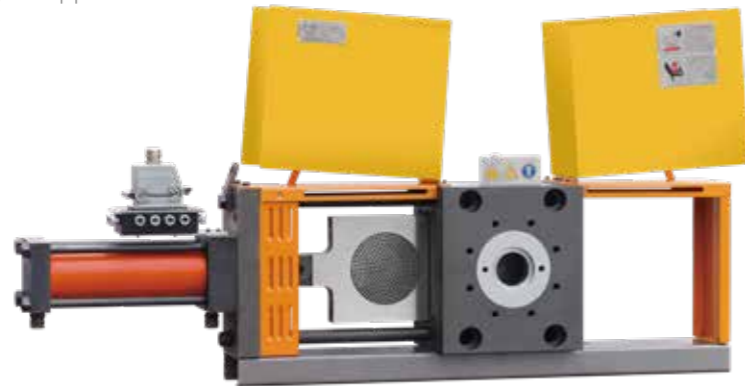

技术参数 Technical parameter

型号 Model	产量(Kg/h) Output	滤网规格 (mm) Filter size	过滤面积(mm ²) Filtration area	最高承压(Mpa) Withstanding pressure	温控分区 Heating zone	加热功率 (KW) Heating power
JW-DB-50	50~100	Φ55	1960	30	2	5
JW-DB-70	80~150	Φ75	3850	30	2	6
JW-DB-100	150~350	Φ105	7850	30	3	6
JW-DB-120	250~400	Φ125	11300	30	3	6.4
JW-DB-150	350~600	Φ155	17670	25	3	7
JW-DB-180	450~1000	Φ185	25440	25	3	8
JW-DB-200	550~1300	Φ205	31415	20	3	12
JW-DB-250	850~1700	Φ255	49087	20	3	13
JW-DB-300	1100~2000	Φ305	70685	20	3	14



双板不停机液压换网器系列:

- 采用先进的压力密封技术，通过聚合物在网前的压力驱动密封元件，达到最佳密封效果，且换网更迅速。
- 优质合金钢经氮化处理，大幅延长产品使用周期。
- 交替式工作模式，能保证在换网过程中的料流连续、稳定以及工艺参数的可重复性。
- 经过流变优化后的蜂窝板，有效降低了挤出过程中流体剪切。
- 采用内加热装置，安全节能。全封闭走线，美观大方。
- 模块化组合模式，适合不同标准挤出机，且清理方便。

Double-panel hydraulic non-stop screen changer series:

- Adopts advanced pressure seal technology, through the pressure of polymers to drive seal components, to achieve the best sealing effect and change screen more quickly.
- Using high grade alloy steel, after nitriding process to extended product life span greatly.
- Alternating work mode, can guarantee the material flow continuous, stability and the process parameters of repeatability,when change the screen.
- After optimization of rheological through cellular plate, to reduce the extrusion process fluid shear.
- Using inner heating device, for the safe and energy-saving. Fully enclosed wires, for the elegant appearance.
- Modular combination patterns, suitable for different standard extrusion machine, and convenient to clean.

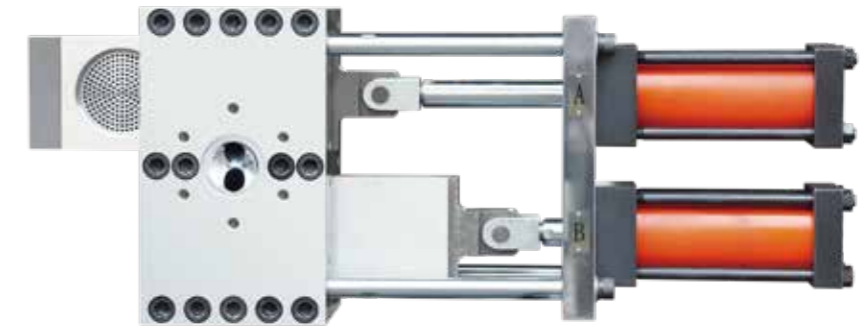

技术参数 Technical parameter

型号 Model	产量(Kg/h) Output	滤网规格 (mm) Filter size	过滤面积(mm ²) Filtration area	最高承压(Mpa) Withstanding pressure	温控分区 Heating zone	加热功率 (KW) Heating power
JW-TB-50	50~100	Φ55	1960x2	30	4	18
JW-TB-70	80~150	Φ75	3850x2	30	4	18
JW-TB-100	150~380	Φ105	7850x2	30	6	18
JW-TB-120	350~700	Φ125	11300x2	30	6	20.4
JW-TB-150	400~1000	Φ155	17670x2	25	6	22
JW-TB-180	700~1300	Φ185	25440x2	25	6	27.2
JW-TB-200	850~1700	Φ205	31415x2	20	6	41.6
JW-TB-250	1100~2200	Φ255	49087x2	20	6	52
JW-TB-300	1500~2600	Φ305	70685x2	20	6	72

Plastic Melt Measuring Gear Pump

熔体计量泵



在挤出生产线上安装一台齿轮泵，通过泵前准确的测压，通过PLC调节挤出机速度，保持压力稳定、有序提供料流来优化供料过程。广泛用于如PC、PMMA、ABS、PET、PVB、PS、PP、PE等高低粘度物料的计量和增压。壳体采用优质合金钢制造，齿轮用淬硬的铬钢或其他优质金属材料制造，具有高效、防漏等优点。

Equipping a gear pump in front of the extruder, checking pressure before the pump and controlling the speed of extrusion, which can minimizing pulsation and irregular material feeding and ensures the polymer is smoothly extruded and continuously delivered to the die head. The system can be widely used to measuring and adding pressure for PC, PMMA, ABS, PET, PVB, PS, PP, PE. The shell of the pump adopts high-quality alloy-steel and the gear uses quenched chrome steel or other high-grade metallic materials which ensures high efficiency and leakage-proof.



技术参数 Technical parameter

型号 Model	排量(CC/r) Volume	转速(rpm) Round speed	产量(Kg/h) Output	传动功率(kw) Driving power
JW-30	30	20-100	30-150	3
JW-50	50	20-100	50-280	5.5
JW-100	100	20-95	110-500	7.5
JW-150	150	20-85	200-900	11
JW-250	250	20-70	300-1200	18.5
JW-400	400	20-70	400-1600	22



各种单层、多层共挤模头，适用PC、PMMA、APET、PETG、ABS、PS、HIPS、PVC、PP、PE、PU、PVDC等原料，选配不同类型的三辊压光机，可生产各种透明板、彩板、发泡板，中空阳光板、洁具板、铝塑复合板、防水卷材、专用地板革，以及各种食品、服装、医药等包装材料、文具片材、光膜、压纹膜、涂膜等。

We produce not only a variety of single-layer/multi-layer co-extrusion dies suitable for materials including PC, PMMA, AP-ET, PETG, ABS, PS, HIPS, PVC, PP, PE, PU, EVA, PVDC, but also other products such as high transparency panels, color panels, foaming sheet, hollow sunshine boards, sanitary ware sheet, aluminum-plastic composite panel, water-proof coils, special floor leather and various materials for food, clothes and medicine package, sheet materials for stationery, light film, graining film, coating film and so on.

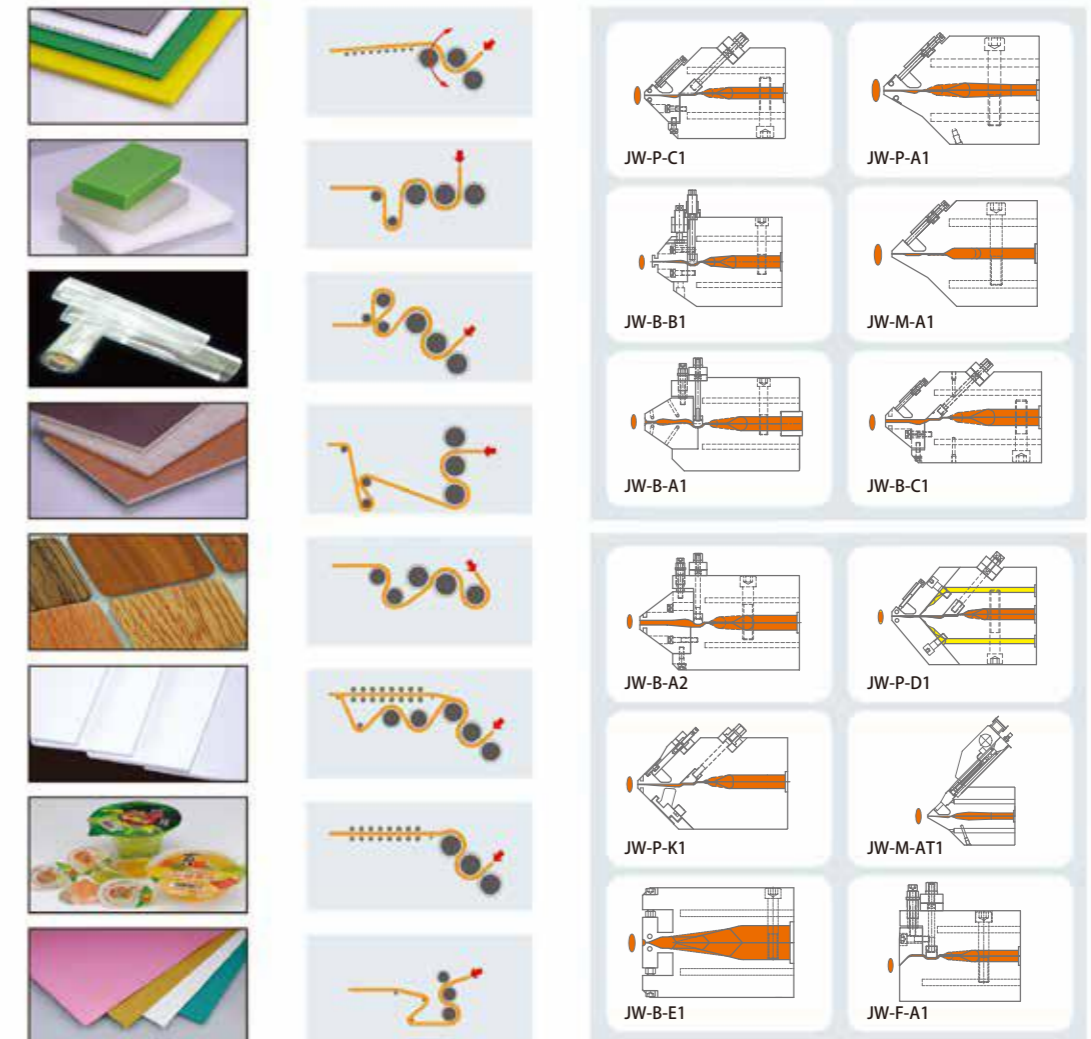

Production Base

生产基地



Jwell Machinery
Suzhou Factory
金纬机械苏州厂区



Jwell Machinery
Haining Factory
金纬机械海宁厂区



Jwell Machinery
Shanghai Factory
金纬机械上海厂区



Jwell Machinery
Changzhou Factory
金纬机械常州厂区



Jwell Machinery
Zhoushan Factory
金纬机械舟山厂区

Sales service network

遍布全球的销售服务网络



公司产品已遍布全国各地，并出到俄罗斯、印度、韩国、印尼、中东、非洲和南美洲、西班牙、意大利等100多个国家和地区，深受客户好评。

Our customers are all over china, and we have customers in Russia, India, Korea, Indonesia, Middle East, South America, Spain, Italy and other countries and areas. Our machines are well accepted by our customers.